RA-MINI ALU

IN-LINE ACTUATOR SERIES

User Manual



REGNER®

Improving lives through technology

www.regner.es

RA-MINI ALU IN-LINE ACTUATOR SERIES USER MANUAL

© JUNE 2019 | Regner Engineering SLU | All rights reserved

Specifications are subject to change without notice.

It is the responsibility of the user to determine the suitability of REGNER® products for a specific application.

No part of this publication may be reproduced without written permission from Regner Engineering SLU.

00. Contents

01. Preface.....	4
02. Safety	4
03. Declaration of Conformity	5
04. Warranty.....	6
05. Specifications	6
06. Installation	9
07. Maintenance	10
08. Troubleshooting.....	11
09. Application Policy.....	11
10. Contact	11

01. Preface



Thank you for choosing a REGNER® electric linear actuator. REGNER® actuators are high-tech products, carefully designed and manufactured in Europe. We use premium raw materials and we continue to work on developing better actuators to respond to the demands of our customers.

This manual will provide you with operational, maintenance and safety information about the actuator. We urge you to read this manual carefully and to follow its recommendations to make sure that the actuator is used properly and to its full potential.

The REGNER® team

02. Safety

Please read the following safety information carefully and make sure that everyone using, connecting or installing the actuator has the necessary skills and information, as well as access to this user manual.

02.01. Safety Guidelines

- Only properly qualified personnel can perform mechanical and electrical installation of the actuator.
- Do not mount, dismount or perform maintenance work while the actuator is in operation.
- Check that the actuator is correctly mounted before operating the device.
- Make sure that the connection bolts can withstand the wear and that they are safely secured before operating the device.
- Check that the actuator can move freely throughout the whole working area before operating the device.
- Use the actuator only within the specified working limits.
- Check that the actuator is connected to a power supply with the correct voltage and current source before operating the device.
- Switch off the main power supply when the actuator is not in use to prevent unintentional operation.
- Do not exert force on the side of the actuator.
- Make sure that the cable cannot be pressed upon, pulled or subjected to any other stress.
- Never unplug any cables or connectors during operation or with power on.
- Stop using the actuator immediately if it seems faulty or broken.
- Never try to open the actuator, as that will compromise the sealing and the proper functioning of the device.
- Do not kick or step on the actuator.
- Check the actuator and joints for extraordinary wear periodically.
- Keep out of reach of children.

02.02. Symbols Used

Important safety information is described under the following two symbols:



WARNING!

Failure to follow these instructions can result in serious personal injury.



CAUTION!

Failure to follow these instructions can result in the actuator being damaged or destroyed.

03. Declaration of Conformity

REGNER ENGINEERING, S.L.U.

Ripollès, 4.17181 Aiguaviva

We, manufacturer of electric linear actuators, declare that our

RA-MINI Electric Linear Actuator Series

Models: RA-MINI XX.XXX.XXX.XXX.XX

to which this declaration refers complies with the following standards:

- EN 60730-1: 1991. Automatic Electrical Controls for Household and Similar Use. Part 1: General Requirements.
- EN 60730-2-14: 1991. Automatic Electrical Controls for Household and Similar Use. Part 1: Particular Requirements for electric actuators.
- EN 50581:2012. Technical documentation for the assessment of electrical and electronic products with respect to the restriction of hazardous substances.

In accordance with the provisions of the directives:

- 2014/30/EU OF THE EUROPEAN PARLIAMENT AND OF THE COUNCIL of 26 February 2014 on the harmonization of the laws of the Member States relating to electromagnetic compatibility (EMC).
- 2011/65/EU OF THE EUROPEAN PARLIAMENT AND OF THE COUNCIL of 8 June 2011 on the restriction of the use of certain hazardous substances in electrical and electronic equipment (RoHS2).

Aiguaviva, 2018-03-09



Mariona Julià

Director of Quality and Regulatory Affairs

04. Warranty

All REGNER® products have a warranty against manufacturing defects. The warranty period begins on the purchase date of the product. The seller is responsible for nonconformities that become apparent within the time stipulated by the applicable law.

04.01. Warranty Exclusions

REGNER® is entitled to deny any warranty if:

- The actuator has not been used correctly or its usage specifications (load, temperature, duty cycle, voltage, current, etc.) have not been respected.
- The actuator has not been maintained correctly.
- The actuator has been manipulated.
- The actuator has been exposed to violent or abrasive treatment.

Nonconformities due to reasonable wear and tear of the actuator over time (such as faded paint) are excluded from warranty.

REGNER® reserves the right to request the return of all allegedly defective products for testing and verification.

Any additional warranty obligations for parts replaced free of charge or for any service provided without charge under this warranty shall be excluded. The warranty period for parts replaced under warranty will end on the expiry date of the warranty period of the main product.

05. Specifications

05.01. Label

www.regner.es

RA-MINI ALU 45.30.87.350.D4

Customer Ref.: XXXXX

Batch No: XXXXXX



01. RA-MINI ALU 45.30.87.350.D4

- RA-MINI ALU: actuator type
- 45: max. load (N)
- 30: stroke length (mm)
- 87: retracted length, center to center (mm)
- 350: cable length (mm)
- D: rod end (D = standard / H = clevis)
- 4: mounting hole diameter (mm)
- Ø: Position control (Ø = Limit switches only, P = potentiometer).



02. Customer Ref.: XXXXXXX

Optional. Customer reference for the product.

03. Batch No.: XXXXXXX

Identification number assigned to a particular lot of products that enables REGNER® to control their quality and trace their constituent parts.

04. Symbols

Symbol	Norms
	WEEE Directive 2002/96/EC
	Compliance to all relevant CE directives

05.02. Components

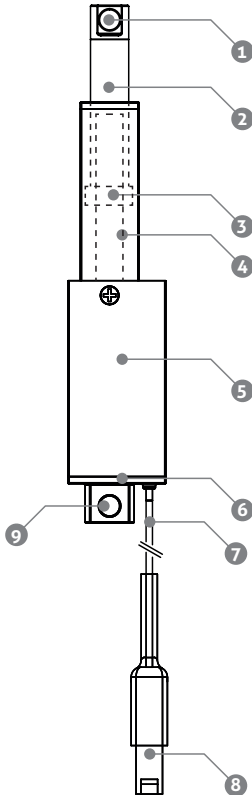

- 1. Rod end
- 2. Rod
- 3. Nut
- 4. Spindle
- 5. Housing
- 6. Seal
- 7. Cable
- 8. Connector (MOLEX 39-01-2066)
- 9. Mounting hole

05.03. Specifications

General Specifications

Stroke	30, 50 or 100 mm
Max. load	70 N at 3.5 mm/s
Max. speed (no load)	14.7 mm/s
Backlash	0.1 mm
Power supply	12 VDC
Max. current	114 mA
Starting current	200 mA
Overcurrent prot.	116 mA
Integrated limit switch	Integrated in "Limit Switches" version. Not available in "Potentiometer" version.
Connector	Molex 39-01-3029
IP rating	IP54
Retracted length (center to center)	57.5 mm + stroke
Weight (30 mm rod)	45 g
Housing material	Aluminum
Rod material	Polished stainless steel
Color	Anodized black (RAL 9005)
Mounting holes Ø	4.1 mm
Cable length	350 mm
Operating temp.	-10 °C to +40 °C
Storage temp.	-30 °C to +70 °C
Duty cycle	30 % (6 out of 20 min.)
Noise (no load)	50 dB at 45 cm
Max. side load (30 mm stroke, extended)	10 N
Lead	5 mm

Preset Configurations

	High-speed reducer (100:1)	Standard reducer (210:1)	High-force reducer (298:1)
Max. peak load	20 N at 9.0 mm/s	45 N at 3.5 mm/s	70 N at 3.6 mm/s
Rated load	7.5 N at 12.5 mm/s	20 N at 5.0 mm/s	30 N at 4.4 mm/s
Max. speed (no load)	14.7 mm/s	5.9 mm/s	4.6 mm/s
Max. current	114 mA	76 mA	114 mA

05.04. Force Curves

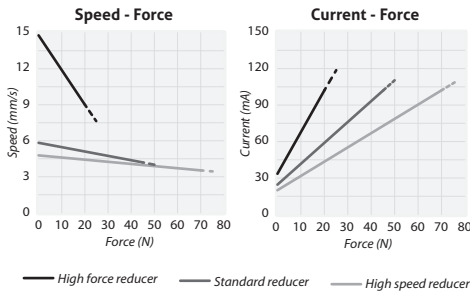

05.05. Overcurrent Protection

In the event of an obstruction or an excessive load, the overcurrent protection feature will cut off the current at 3 A to protect the actuator. The overcurrent protection system resets after 10 seconds when activated to enable normal operation.

05.06. Electronic Limit Switches (opt.)

When the actuator reaches its fully extended or fully retracted positions, an electronic limit switch automatically cuts off the current to prevent damage to the motor. When it reaches either stroke end point, the actuator can move only in the opposite direction,

until it is separated from the limit and it can resume its normal function and move freely in either direction.

05.07. Position feedback (opt.)

The position feedback potentiometer is fed with a 5 VDC voltage. Depending on the position of the rod, the potentiometer sends an analog signal between 0 VDC (actuator fully retracted) and 5 VDC (actuator fully extended).

05.08. Dimensions

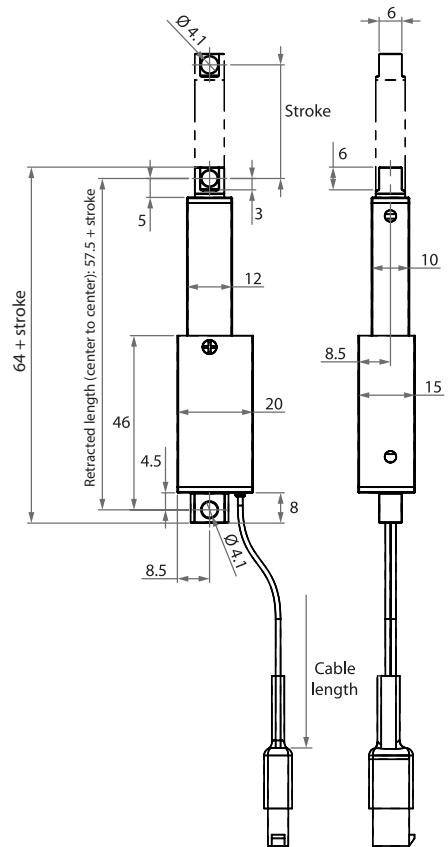

All measurements are in mm.

06. Installation

06.01. Mechanical Installation

To install a REGNER® actuator, simply slip a pin through the hole on each end. Mounting pins must be parallel to each other to keep the actuator from bending and being damaged.

The actuator should be installed so that the force of the load is exerted on the center of the rod. Excessive off-center loads may cause bending and lead to premature failure.

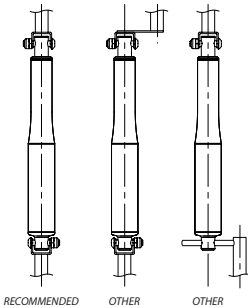

To prevent premature wear, make sure that the mounting pins are fixed at both ends, are solid, and do not have excessive free play. However, the actuator must be able to rotate around the pivot point of the rod, as this will allow the actuator to move freely along the full stroke length, both in the development phase and during normal operation. Examine the area around the housing and see that no components can get trapped and damage the application and the actuator.



CAUTION!

- Mounting pins must have the correct dimensions and limited free play.
- Any bolts and nuts used for the installation must be made of high-quality steel.
- Do not apply an excessive torque on the mounting bolts to avoid stressing the fixtures.



CAUTION!

- The rod can turn a maximum of 90°.

Max. 90°



WARNING!

If the actuator is used in an application that may cause personal injury, it is the responsibility of the application manufacturer to introduce the necessary safety measures to prevent personal injury in case of failure.



WARNING!

REGNER® actuators are not designed to be used in the following applications: aircraft, explosive environments, nuclear power generators, and offshore installations.

06.02. Electrical Installation

- Voltage must be switched off when the rod reaches the ends of the stroke or if an excessive load occurs mid-stroke to prevent damage to the actuator.
- Make sure that the switch can handle the maximum motor current.

LIMIT SWITCHES OPTION

Connector: Molex 39-01-3029



POTENTIOMETER OPTION

Connector: Harwin M20-1060500

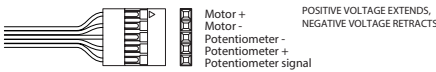

CAUTION!

- Make sure the leads and cables leading to the motor can handle the maximum motor current.
- For additional protection, use a fuse between the actuator and the power source.
- Do not work on the actuator or the wiring with the power switched on!

Wire cross-sections

To avoid malfunctions due to voltage drops, the cross-section of the wires connecting the actuator and the power supply must have an appropriate diameter.

Position feedback power supply

The potentiometer should be powered at 5 VDC. Do not use a higher voltage.

- Standard output: 0 - 5 VDC \pm 3%.

07. Maintenance

The actuator is a closed unit and does not require internal maintenance. In fact, the actuator is not to be opened by unauthorized personnel. However, some external maintenance must be performed on a regular basis:

- Clean the actuator with a dry cloth to remove dust and dirt.
- Inspect the actuator for mechanical damage or wear.
- Inspect the actuator's attachment points, cables, rod ends, housing, and connector, and check that the device works correctly.

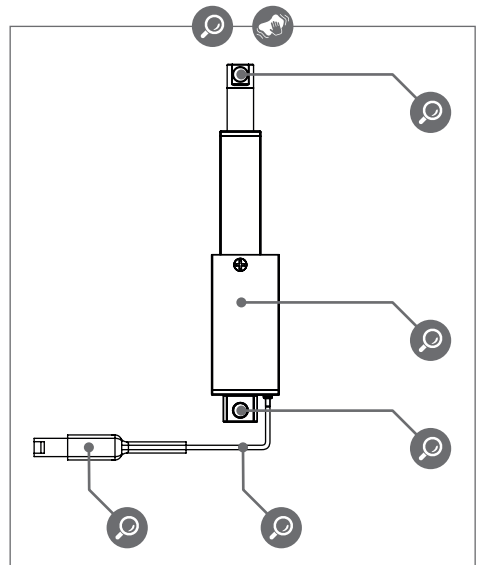

08. Troubleshooting

Symptom	Possible cause	Action
<i>The motor produces no sounds or the rod does not move.</i>	<ol style="list-style-type: none"> 1. Actuator not properly connected to the power supply. 2. Burned fuse. 3. Damaged cable. 	<ol style="list-style-type: none"> A. Check the connection to the power supply or the control unit, if any. B. Please contact REGNER®.
<i>Excessive electricity consumption.</i>	<ol style="list-style-type: none"> 1. Misaligned or excessive load. 	<ol style="list-style-type: none"> A. Align or reduce the load. B. Run the actuator with no load. C. Please contact REGNER®.
<i>The motor runs but the spindle does not move.</i>	<ol style="list-style-type: none"> 1. Damaged gearing system or spindle. 	<ol style="list-style-type: none"> A. Please contact REGNER®.
<i>The actuator cannot lift a full load.</i>	<ol style="list-style-type: none"> 1. Misaligned or excessive load. 2. Insufficient power supply. 3. Current cut off due to excessive load. 4. Damaged motor. 	<ol style="list-style-type: none"> A. Wait for the overcurrent protection system to reset (5 minutes). A. Align or reduce the load. B. Check the power supply. C. Please contact REGNER®.

<i>The motor runs too slowly, does not run with full force or runs in smaller steps.</i>	<ol style="list-style-type: none"> 1. Excessive load. 2. Voltage drop in the cable (long cables may affect performance). 3. Current cut off due to excessive load. 	<ol style="list-style-type: none"> A. Wait for the overcurrent protection system to reset (5 minutes). B. Reduce the load. C. Check the power supply.
--	---	--

<i>The actuator cannot hold the load.</i>	<ol style="list-style-type: none"> 1. Excessive load. 	<ol style="list-style-type: none"> A. Reduce the load.
---	--	---

09. Application Policy

REGNER® products can be used in a wide range of applications in health care, household or industrial equipment, for example. REGNER® cannot know and check all the conditions in which REGNER® products are installed and used. The suitability and functionality of a REGNER® product, as well as its performance in a variety of conditions, can only be verified by testing, and it shall ultimately be the responsibility of the customer using a REGNER® product.

REGNER® is solely responsible that REGNER® products comply with the established specifications, whereas it remains the responsibility of the customer to ensure that a specific REGNER® product can be used for a specific application.

10. Contact

For technical assistance, please contact the REGNER® Technical Department at info@regner.es.



Ripollès, 4 | 17181 Aiguaviva (Girona) SPAIN | Tel. +34 972 476 911 | Fax +34 972 475 803
info@regner.es | www.regner.es